

# DURA

**ITEM #3748-3745A-3748A**















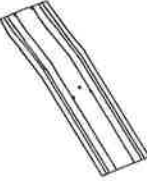
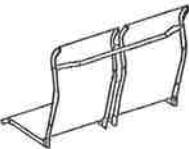



**PARADIS**







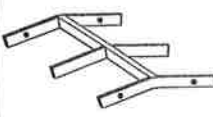





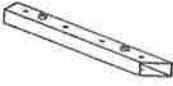







## Instructions générales

1. Avant de commencer l'assemblage, comptez et vérifiez la liste des pièces afin de s'assurer que toutes les pièces sont dans la boîte.
2. Cette structure devrait être montée sur un terrain plat
3. Conservez ces instructions pour référence future.
4. Ne pas serrer les vis jusqu'à ce que la structure soit entièrement assemblée.
5. Ne pas retourner au vendeur. Au cas où vous avez besoin de pièces ou de l'aide, appelez-nous du lundi au vendredi de 9:00 à 16:30 au (1-888) 288-3872 ou par courriel à [brenda@durahousewares.com](mailto:brenda@durahousewares.com) ou [jill@durahousewares.com](mailto:jill@durahousewares.com)
6. S'il vous plaît, suivez les instructions étape par étape et vous n'aurez pas de problème de montage.
7. Des soins adéquats vous donneront plusieurs années d'utilisation de ce produit.
8. Si vous avez des pièces endommagées et que vous avez besoin de remplacement, s'il vous plaît envoyez des photos et preuve d'achat par courriel afin que nous puissions mieux vous servir.
9. Nous avons inclus quatre roues supplémentaires en plastique dans la boîte. Si vous trouvez que le mécanisme est trop bruyant, vous pouvez remplacer les roues métalliques avec ceux en plastique. Cependant, vous devez vous rappeler d'enlever les roues en plastique en hiver (Extrême froid pourrait les endommager)

## General instructions

1. Before you start the assembly, count and check the parts list to make sure that all parts are in the box.
2. This structure should be mounted on flat even ground.
3. Keep this instructions sheet for future reference.
4. Do not tighten screws until structure is fully assembled.
5. Do not return to vendor. In case you need parts or help, call us Monday to Friday from 9:00 am to 4:30 pm at (1-888) 288-3872 or email us at [brenda@durahousewares.com](mailto:brenda@durahousewares.com) or [jill@durahousewares.com](mailto:jill@durahousewares.com)
6. Please follow step by step instructions and you will not have any assembly problem.
7. Proper care will give you years of usage of this product.
8. If you have damaged parts and you need replacement please send pictures and receipt by email, so we can serve you better

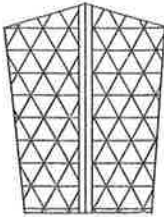
PART/PIECE	FIGURE/DESSIN	QTY/QTEE	PART/PIECE	FIGURE/DESSIN	QTY/QTEE	PART/PIECE	FIGURE/DESSIN	QTY/QTEE
A		1	G	 ø16*ø8*30	8	M		1
B		1	H	 ø18*ø8*20	4	N		2
C		2	I		66	O		1
D		4	J	 25*15*1330	2	P		2
E		2	J0	 25*15*1330	2	Q		2
E1		2	J1	 25*15*1300	2	R		2
F	 42*14*1100	4	K		1	S		1

PART/PIECE	FIGURE/DESSIN	QTY/QTEE	PART/PIECE	FIGURE/DESSIN	QTY/QTEE	PART/PIECE	FIGURE/DESSIN	QTY/QTEE
T		4	Z5	 M6*40	8	Z11	 M6*35	4
U		2	Z6	 M6*35	24	V	 Ø12*Ø6.2X1.0	104
Z1	 M6*90	4	Z7	 M6*25	12	W	 M6	64
Z2	 M6*75	8	Z8	 M6*15	12	X		1
Z3	 M6*50	16	Z9	 M6*12	12	Y		1
Z4	 M6*45	8	Z10	 M6*60	4	Y1	 PLASTIC WHEEL REPLACEMENT	4
Y2		1	Y3		1	Y4		24

1

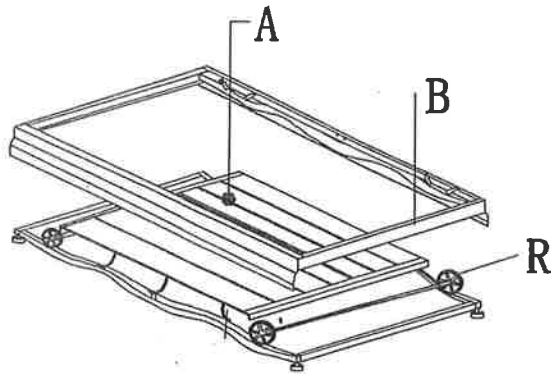

2

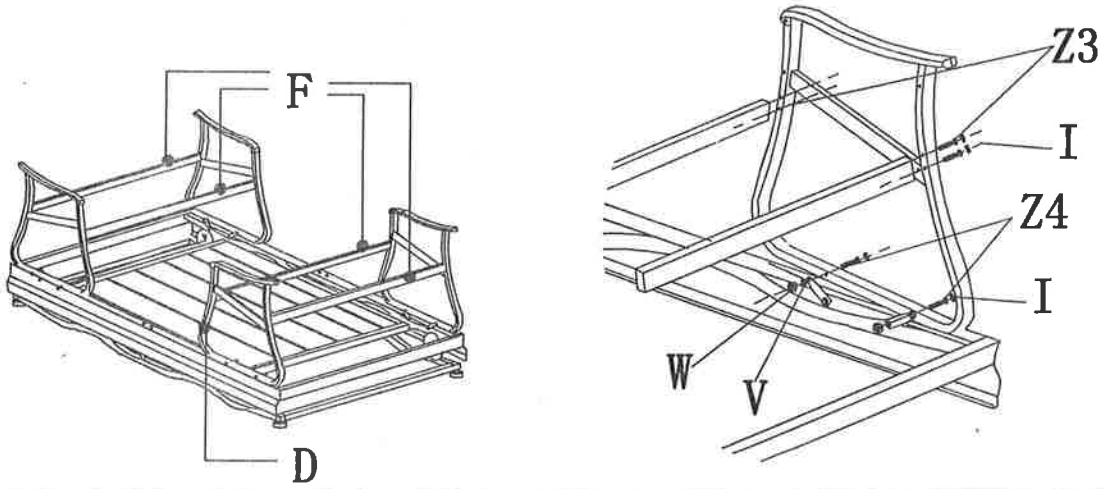

3

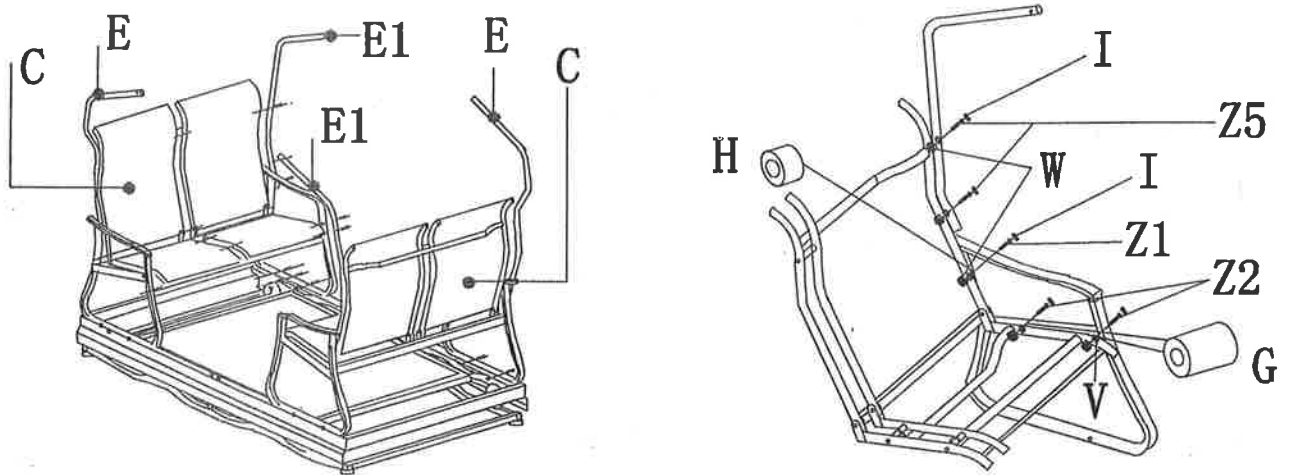

4

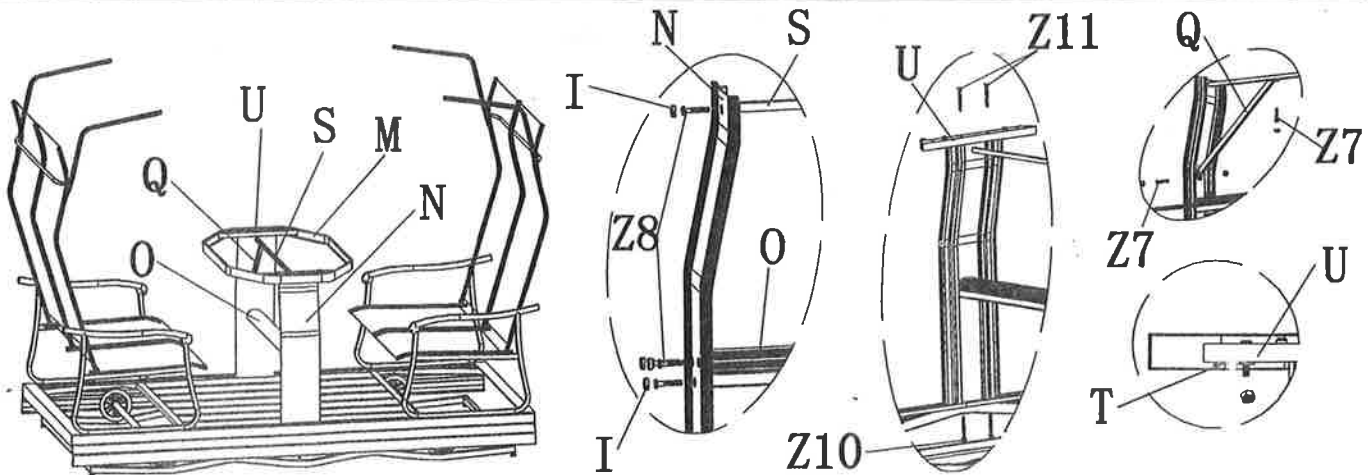

5

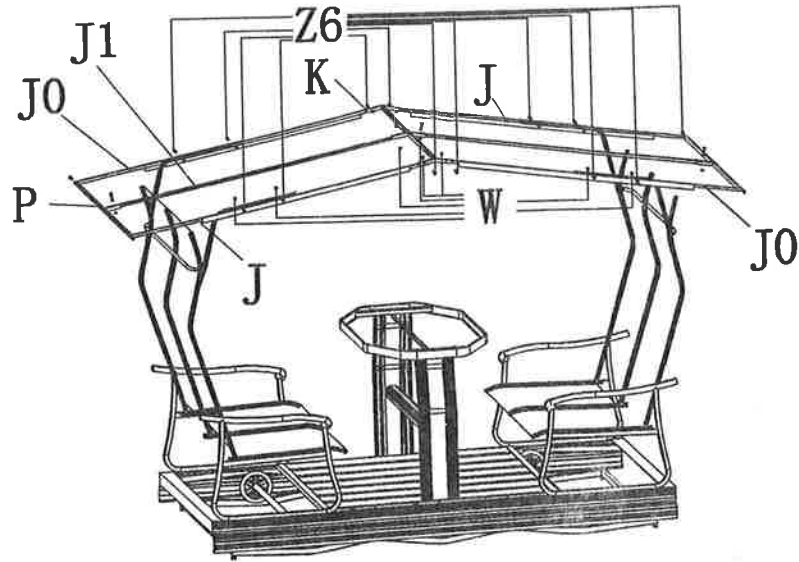

6

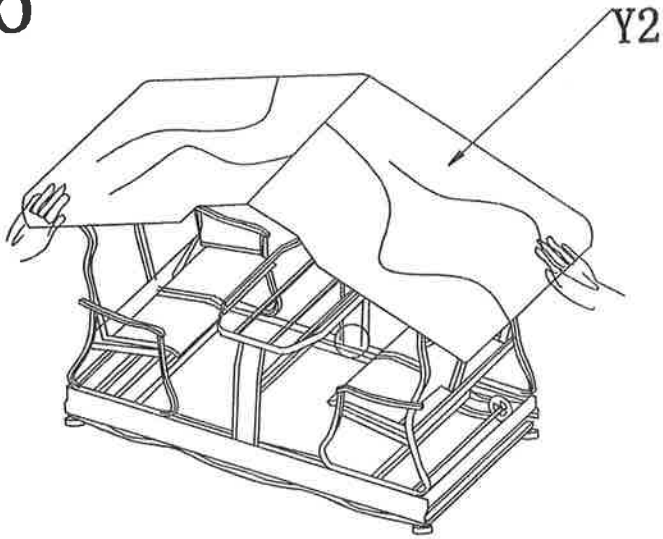

7

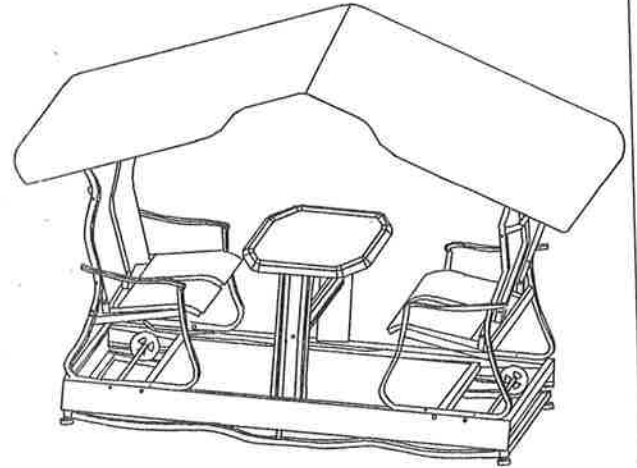

8

